

FLEXIBLE SETUP, SEAMLESS WORK

THE LISTA WORKSTATION SYSTEM



THE WORKSTATION FOR EVERY NEED

Setting up a workstation sounds simple, but it can be a very complex challenge of modern workspace design. Our working environment is constantly changing, and this places many requirements on the design, position and overall flexibility of the workspace. With the LISTA workstation system, you have a solution you can rely on to meet every requirement: it has a modular structure and can therefore be flexibly adapted to individual requirements. At the same time, its ergonomic functionality makes workstations particularly neat and efficient. The LISTA workstation provides a smooth workflow, highly efficient and productive workspace even in special environments such as lean production and ESD areas.





+ Total flexibility

- Comprehensive and modular range of products
- All modules can be easily combined
- Mobile elements can be linked for flow-optimised processes
- Easy installation, adjustment and extension at any time

+ Optimum ergonomics

- Individually coordinated workflow, storage and lighting
- Manual or electric height adjustment

+ Organisation in line with the 5S principle

- High functionality and well thought-out design
- Universal LISTA partition material
- Individual locking and access systems
- Flexible colour design for ease of use

+ ESD model

- Effective protection against electrostatic discharge
- Reduce cost of compromised components
- Optimised solutions for workstation and storage

+ Customer-specific designs

- Special sizes and designs
- Special storage areas, covers and recesses
- Individual planning by the LISTA team

LISTA WORKSTATIONS IN PRACTICE

Thanks to its modular structure and the wide range of configuration options, the LISTA workstation system is suitable for a wide range of tasks and applications, from assembly and production to shipping,

LISTA workstations can be found in virtually all market sectors and numerous companies worldwide. Typical examples include:



Assembly workstation

- Electrically height-adjustable workstation frame (move, C design) with synthetic resin worktop for all types of assembly applications
- Configurable accessories such as swivel arms and container strips within ergonomic reach
- Integrated power conduit for assembly with power modules
- Equipped with dimmable workstation lighting



Testing workstation

- Electrically height-adjustable workstation frame (move, C design) with synthetic resin worktop
- Ergonomic workstation equipment and lighting with dimmable magnifying glass and side light in LED technology
- Integrated power supply and neat cable management
- Also available as an ESD version





Heavy-duty workstation

- Electrically height-adjustable workstation (move, H design) on four legs
- High load capacity of 400 kg
- Robust design, impact and vibration-resistant



Packing table

- Highly flexible thanks to the use of individually designed modules and accessories
- Rear panels can be individually equipped
- Robust storage shelf with dividers
- Cutting tool under workbench



THREE INTO ONE

Heavy duty or assembly area – with the LISTA workstation system you can configure the solution that suits all your tasks and requirements. Each workstation is comprised of three main elements: substructure, universal substructures and worktops. These can be individually equipped and expanded to provide total flexibility.

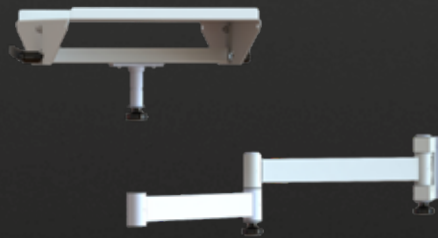

1 Substructures

Depending on the application and area of application, you can choose between substructures in four variants.

from p. 8



move workstation frame in H design, electrically adjustable



move workstation foot in H design, electrically adjustable



move workstation frame in C design, height-adjustable



Workbench leg assembly, fixed or height-adjustable



3 Universal superstructures

Combine substructures and worktops freely and flexibly with the universal superstructures of the LISTA system. Numerous modules and accessories are available from the rear panel to the monitor holder.

see p. 16 ff

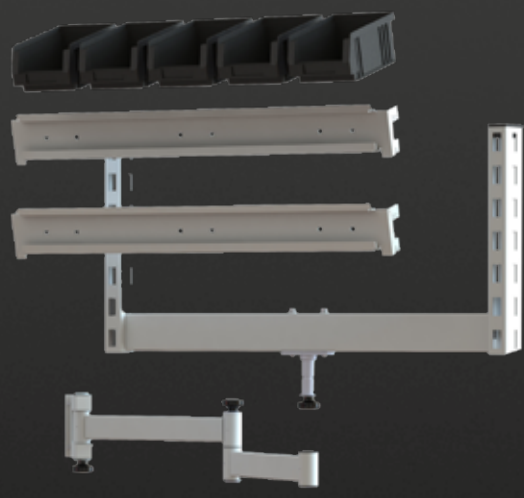

2 Worktops

The LISTA workstation system offers you a wide range of high-quality worktops:

- Eight standard materials for every purpose
 - Six standard widths and five standard depths
- Other worktops and dimensions available on request.

see p. 12 ff.

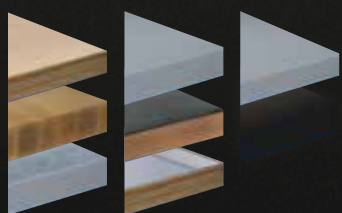

1 SUBSTRUCTURES

Does your workstation require a particularly stable and robust substructure, and must it be accessible or easily height-adjustable? The LISTA workstation system has flexible and configurable modules in four variants tailored to the requirements of different areas of application. In addition to the two electrically adjustable LISTA

move H design workstation frames and legs, our system also includes the C design of the movable workstation frame, which is especially suitable for assembly and control tasks, as well as the classic workbench leg assembly for high loads in workshops and production.

move workstation frame, H design



move workstation frame, H design, electrically height-adjustable

4-legged tubular construction incl. connection for universal superstructures and adjustable legs. Lifting force: max. 400 kg with evenly distributed load. Lift: 500 mm Max. speed 23 mm/s. Incl. control and operating unit. Input via system plug. Without connecting cable. Colour: Lifting unit RAL 9006 white aluminium, outer profile according to colour chart.

W × D × H mm	for top W × D mm	Art. no.
950 × 785 × 680 – 1180	1000 × 800	88.226.XXX
950 × 985 × 680 – 1180	1000 × 1000	88.227.XXX
1450 × 785 × 680 – 1180	1500 × 800	88.228.XXX
1450 × 985 × 680 – 1180	1500 × 1000	88.229.XXX
1950 × 785 × 680 – 1180	2000 × 800	88.230.XXX
1950 × 985 × 680 – 1180	2000 × 1000	88.231.XXX

Height without countertop

Reinforcement angle for move workstation frame, H design

For mounting on countertop and guide rails. D × H: 190 × 272 mm
Colour: as per colour chart.

	Art. No.
Fastening bracket	88.237.XXX

Fastening adapter for hanging drawer cabinets

Can be mounted either on the left or right underneath the countertop. Model: sheet steel. Colour: as per colour chart.

	for width mm	for depth mm	Art. no.
	for 18E	for 27E	88.238.XXX
	for 18E	for 36E	88.239.XXX
	for 27E	for 27E	88.240.XXX
	for 27E	for 36E	88.241.XXX



Keyboard drawer

Pull-out shelf with rear stop. W × D: 550 × 370 mm.
Max. load: 20 kg. Model: sheet steel. Colour: as per colour chart.

	Art. no.
Pull-out keyboard for substructure 550/370	88.242.000

Factory assembly

For workstation frame move, H design, with countertop. Without superstructures and base cabinets.

	Art. no.
Electrically height-adjustable workstation frame installation	88.246.000



For colour information, see p. 31. When ordering, please use the desired three-digit colour code (instead of XXX).

move workstation leg, H design



move workstation leg, H design, electrically height-adjustable

Lifting force: 200 kg/leg with an evenly distributed load. Lift: 500 mm Speed max. 23 mm/s. Colour: Lifting unit RAL 9006 white aluminium, outer profile according to colour chart. Scope of delivery: 1 unit

For your substructure, you need two move work legs, H design, and a 2-fold/4 control unit. A cross brace is generally recommended for stabilisation.

WxDxH mm	for top depth mm	Art. no.
90 × 725 × 680 – 1180	800	88.200.XXX
90 × 925 × 680 – 1180	1000	88.201.XXX

Height without countertop



Convenient operating element

Display of table height. Four favourite positions can be saved. Manual height storage.

Art. no.

Convenient operating element

88.203.000



Control unit two-fold/4K

Set of two controls for workstation leg move, H design, incl. manual switch for ascent/descent and connection cable for motor units. Mains voltage: 100 – 240 V AC. 50 – 60 Hz. IP20. Overload protection. Soft start/stop function. Connection via Wieland system plug. Colour: black.

Art. no.

Control unit set 2-fold/4K

88.202.000



Cross brace

Including fastening material. Model: sheet steel. Colour: as per colour chart. Scope of delivery: 1 unit

Art. no.

for top width (2 legs) mm	for leg distance (centre) mm	Strut length mm	Art. no.
1500	1300	1224	43.233.XXX
2000	1800	1724	43.236.XXX
2500	2300	2224	40.900.XXX



Cross brace for in-line installation

For connecting two workbenches (top with three work legs, 2-part strut). Including fastening material. Model: sheet steel. Colour: as per colour chart.

Art. no.

for top width (3 legs) mm	for leg distance (centre) mm	Strut length mm	Art. no.
2000	900	1648 (2 × 824)	40.833.XXX
2500	1150	2148 (2 × 1074)	43.241.XXX
3000	1400	2648 (2 × 1324)	43.242.XXX

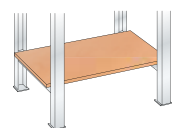

Multiplex/synthetic resin storage shelf

Suitable for attachment between two move workbench legs, H design. Capacity 20 kg. Including fastening material. If a storage shelf is used, a cross brace is required.

Art. no.

Multiplex 20 mm

for top width mm	WxDxH mm	for depth workbench leg move mm	Art. no.
1000	920 × 520 × 20	725	88.212.000
1500	1420 × 520 × 20	725	88.213.000
2000	1920 × 520 × 20	725	88.214.000
1000	920 × 720 × 20	925	88.215.000
1500	1420 × 720 × 20	925	88.216.000
2000	1920 × 720 × 20	925	88.217.000
Special size			88.218.000

Resin 22 mm

for top width mm	WxDxH mm	for depth workbench legs move mm	Art. no.
1000	920 × 520 × 22	725	88.219.000
1500	1420 × 520 × 22	725	88.220.000
2000	1920 × 520 × 22	725	88.221.000
1000	920 × 720 × 22	925	88.222.000
1500	1420 × 720 × 22	925	88.223.000
2000	1920 × 720 × 22	925	88.224.000
Special size			88.225.000

move workstation frame, C design



The LISTA move workstation frame in C design is an especially accessible and flexibly expandable workstation, especially for assembly, testing and control areas. It can be height-adjusted with clamping screws, a hand crank or electric motor. The legs are equipped with levelling screws. A steel frame joins the legs and supports the table top (suitable for table top depths of 620 – 800 mm). Max. 300 kg capacity with evenly distributed load. Model: Steel construction, painted. Colour: lifting unit: Aluminium anodised colourless; outer profile, frame and legs: as per colour chart.



With clamping screws

Table legs height-adjustable using clamping screws.



With hand crank

Table substructure can be mechanically adjusted to any height with the hand crank. The hand crank is removable (centred as standard).

W×D×H mm	for top depth mm	Art. no.
1030×600×700 – 1100	620 – 800	65.300.XXX
1360×600×700 – 1100	620 – 800	65.301.XXX
1780×600×700 – 1100	620 – 800	65.302.XXX

Height without countertop

W×D×H mm	for top depth mm	Art. no.
1030×600×700 – 1100	620 – 800	65.303.XXX
1360×600×700 – 1100	620 – 800	65.304.XXX
1780×600×700 – 1100	620 – 800	65.305.XXX

Height without countertop



With electric motor

Table substructure can be electrically adjusted to any height. The operating unit can be mounted on the left or right (on the right as standard). A connection cable is required for operation, see p. 21.



Fixed casters



Mobile casters

Caster set

For fastening to existing move workstation frame, C design. Designed as temporary roll support to move the workstation quickly and effortlessly. Adjustment range downwards reduced by approx. 25 mm.

W×D×H mm	for top depth mm	Art. no.
1030×600×700 – 1100	620 – 800	65.204.XXX
1360×600×700 – 1100	620 – 800	65.205.XXX
1780×600×700 – 1100	620 – 800	65.206.XXX

Height without countertop

	Art. no.
Caster set	74.991.000



Programmable control system

- Optionally available for automatic adjustment of individual installation heights



Note: The maximum load on the table frame is 300 kg with an evenly distributed load (incl. countertop and add-on elements).

Workbench leg assembly



The LISTA workbench leg assembly is a rugged steel plate construction, welded together with extruded profiles, with holes for fastening the top. The legs can be anchored to the floor through a hole in the base plate. Capacity 400 kg. Max. clear width up to 2220 mm depending on top width. Model: sheet steel. Colour: as per colour chart.

With the LISTA workbench leg assembly, you can configure your workbench precisely to your individual needs: The leg can be supplied fixed or height-adjustable. Different countertops and additional modules – such as our drawer cabinets suitable for under-counter installation – are available. You can find a wide range of LISTA workbenches preconfigured to suit your needs in our main catalogue.



Workbench leg assembly, fixed height

Scope of delivery: 1 unit

W×D×H mm	for top depth mm	Art. no.
80×675×800	700	43.101.XXX
80×675×850	700	43.176.XXX
80×725×800	750, 800	43.111.XXX
80×725×850	750, 800	43.179.XXX



Workbench leg assembly, height adjustable

Scope of delivery: 1 unit

W×D×H mm	for top depth mm	Art. no.
80×675×700 –1050*	700	43.186.XXX
80×725×700 –1050*	750, 800	43.231.XXX

* Height-adjustable in 25 mm increments.



For colour information, see p. 31. When ordering, please use the desired three-digit colour code (instead of XXX).



WORKTOPS

The LISTA workstation system offers the right worktop for every application area, from the universal worktop with linoleum covering to the chrome steel worktop. Another plus point: If the support pillars

for the superstructures are fastened behind the worktop, you can make effective use of the full worktop depth with the LISTA system.



Multiplex top

- Made of steamed beech veneers, glued waterproof and with bevelled edges
- Sanded, oiled and waxed surface
- Versatile, splash-proof, dirt-repellent and largely impervious to oil and grease



Beechwood top

- Made of steamed beech beams, glued waterproof and with bevelled edges
- Sanded, oiled and waxed surface
- Extremely resilient, splash-proof, dirt-repellent and largely impervious to oil and grease



Universal top

- Universal countertop for the workshop
- Linoleum covering, 2 mm
- Impact-resistant and slightly dampening
- Limited scratch resistance



Eterlux top

- For hygienic applications
- HPL coating, 3 mm
- Easy-to-clean surface texture
- Highest scratch resistance
- Heat-resistant up to 180°C, briefly up to 280°C
- Resistant to chemicals and solvents, also acids and alkalis to a certain extent
- Limited impact resistance



Nitrile top

- Technical coating of natural rubber
- With 4 mm rubber top mat
- Medium-hard, slip-resistant and shock-absorbing as well as oil and fuel-resistant
- Can be used at -10°C to +70°C



Metal coverings (on request)

- For high usage
- Very easy to clean and versatile
- Choice of sendzimir galvanised coating and chrome steel coating



Resin top

- Easy-to-clean textured surface with HPL coating, 0.8 mm
- Resistant to common household chemicals, solvents, weak acids and alkalis
- High impact and scratch resistance
- Also available as an ESD model



ABS plate

- With hard, slightly grained surface texture, 2 mm
- High scratch resistance and impact resistance
- Resistant to chemicals, oils and greases

Features	Multiplex	Beech	Universal	Eterlux	Nitrile	Metal coatings	Resin	ABS	PVC mat 4mm
Impact/shock resistance	●	●	●	○	■	●		●	●
Scratch resistance			●	■	○	■	■	■	
Dampening			○		■				■
Cleaning / Hygiene			○	■		■	■	●	●
Heat resistance (soldering)				●		■	○		
Chemical resistance*			○	●	○	■	●	●	○
Acid resistance*			○	●	○	■	●	●	○
Alkali resistance*			○	●	○	■	●	●	○
Resistance to oil and grease*			●	●	●	■	●	●	●

* incl. visual changes

■ applies above average

● applies

○ applies in part



PVC mat, 4 mm, transparent

- Dampening and slip-resistant
- Smooth, soft surface, easy to clean and impact-resistant
- Resistant to chemicals, solvents, weak acids and alkalis with brief exposure

Art. no.

Size max. 4000×1500

39.574.000



Screwed inserts, pre-assembled

- For easy attachment of countertops to frame or leg

Model

Model	for top thickness mm	Number of screws	Art. no.
For move workstation frame C design	30	9×M6	88.234.000
For move workstation leg, H design	40 – 50	6×M10	88.232.000
For move workstation frame, H design	30 – 50	12×M8	88.233.000
For workbench leg assembly	40 – 50	6×M10	39.327.000
For suspended drawer cabinet	40 – 50	4×M10	39.161.000



Special and custom solutions on request

Special sizes	Thickness mm	max. size mm	Item
Multiplex	40	2500×1250	39.344.000
	50	2500×1250	41.995.000
Beech	40	3000×1200	39.075.000
	50	3000×1200	39.020.000
Universal	53	3000×1250	39.572.000
Eterlux	52	2750×1250	39.573.000
Nitrile	43	3000×1000	39.952.000
	50	3000×1000	39.956.000
Resin	23	2740×1200	39.881.000
	40	3000×1000	39.085.000
ABS	40	2000×1000	42.519.000

Other top types

- Chrome steel top, sealed, for pharmaceutical and laboratory use

Customer-specific cut-outs and holes

- According to your specifications





Multiplex

Width
mm

1000

Depth
mm

700

800

1000

Beech

Thickness
mm

30**

88.251.000

88.252.000

88.253.000

Multiplex

40

-

-

-

50

-

-

-

Beech

40

-

-

-

50

-

-

-

Universal

Universal

53

-

-

-

Eterlux

52

-

-

-

Nitrile

43

-

-

-

50

-

-

-

23

-

-

-

Eterlux

Resin

30**

88.267.000

88.268.000

88.269.000

40

-

-

-

ABS

40

-

-

-

Nitrile

Width
mm

2000

Depth
mm

620

700

750

Metal coatings

Thickness
mm

30**

88.262.000

88.263.000

-

Multiplex

40

-

42.851.000

40.027.000

50

-

42.855.000

40.047.000

Beech

40

-

89.685.000

89.693.000

50

-

89.689.000

40.003.000

Resin

Universal

53

-

-

39.556.000

Eterlux

52

-

-

39.565.000

Nitrile

43

-

-

42.923.000

50

-

-

42.927.000

23

-

-

-

ABS

Resin

30**

88.278.000

88.279.000

-

40

-

-

39.083.000

ABS

40

-

-

-

* with Multiplex tops 3000 mm = 2x1500 mm glued

1200				1500				
620	700	800	1000	620	700	750	800	1000
88.254.000	88.255.000	88.256.000	88.257.000	88.258.000	88.259.000	-	88.260.000	88.261.000
-	-	-	-	-	42.850.000	40.025.000	39.035.000	-
-	-	-	-	-	42.854.000	40.045.000	40.185.000	-
-	-	-	-	-	89.684.000	89.692.000	89.696.000	-
-	-	-	-	-	89.688.000	40.001.000	39.015.000	-
-	-	-	-	-	-	39.555.000	39.559.000	-
-	-	-	-	-	-	39.564.000	39.568.000	-
-	-	-	-	-	-	42.922.000	42.930.000	-
-	-	-	-	-	-	42.926.000	42.934.000	-
-	-	-	-	-	-	-	-	-
88.270.000	88.271.000	88.272.000	88.273.000	88.274.000	88.275.000	-	88.276.000	88.277.000
-	-	-	-	-	-	39.082.000	39.052.000	-
-	-	-	-	-	-	-	-	-

2000		2500		3000*			
800	1000	700	750	800	700	750	800
88.264.000	88.265.000	-	-	-	-	-	-
39.037.000	-	42.852.000	40.028.000	39.039.000	42.853.000	42.858.000	42.860.000
40.187.000	-	42.856.000	40.048.000	40.188.000	42.857.000	42.859.000	42.861.000
89.697.000	-	89.686.000	89.694.000	89.698.000	89.687.000	89.695.000	89.699.000
39.017.000	-	89.690.000	40.004.000	39.018.000	89.691.000	40.005.000	39.019.000
39.560.000	-	-	39.557.000	39.561.000	-	39.558.000	39.562.000
39.569.000	-	-	39.566.000	39.570.000	-	-	-
42.931.000	-	-	42.924.000	42.932.000	-	42.925.000	42.933.000
42.935.000	-	-	42.928.000	42.936.000	-	42.929.000	42.937.000
-	-	-	-	-	-	-	-
88.280.000	88.281.000	-	-	-	-	-	-
39.076.000	-	-	39.134.000	39.135.000	-	39.084.000	39.086.000
-	-	-	-	-	-	-	-

** Suitable for move C or H design, workstation frame

OVERVIEW OF UNIVERSAL SUPERSTRUCTURES

With our universal superstructures, you can design each workstation ergonomically, neatly and individually. The consistent and form-fitting design ensures an attractive appearance and enables virtually invisible cable routing. All superstructures are easy to install and also available as an ESD model.



Cantilever, single, double sided

- Integrated and interlocking design for almost invisible cabling.

see page 19



Rear panels

- Perforated or smooth
- For attaching tool holders
- Smooth rear panels can also be mounted on the back for a complete room partition

see page 19

Support pillars

- Flexibly mountable
- Vertically adjustable in increments of 50 mm
- Continuously adjustable horizontally for flexible attachment to any substructure

see page 18

Rear power panel

- For accommodating power modules and elements
- Fully integrated into the rear panel
- Simple assembly and dismantling

see page 20

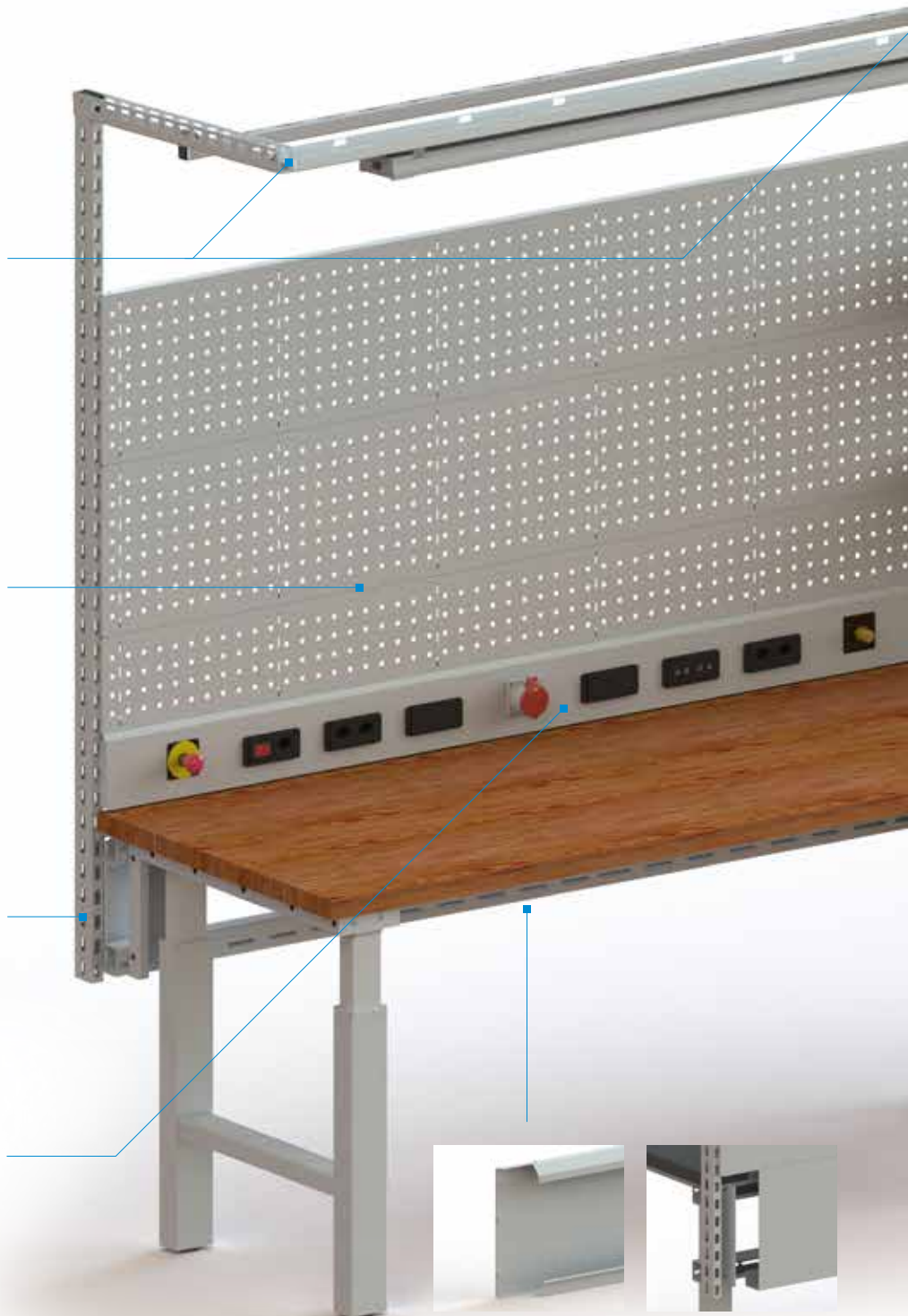

Cable trough (visualisation: sectional view)

- Fastening to the rear side of support pillars
- Optimum cable routing and protection
- Suitable for linked solutions

see page 19

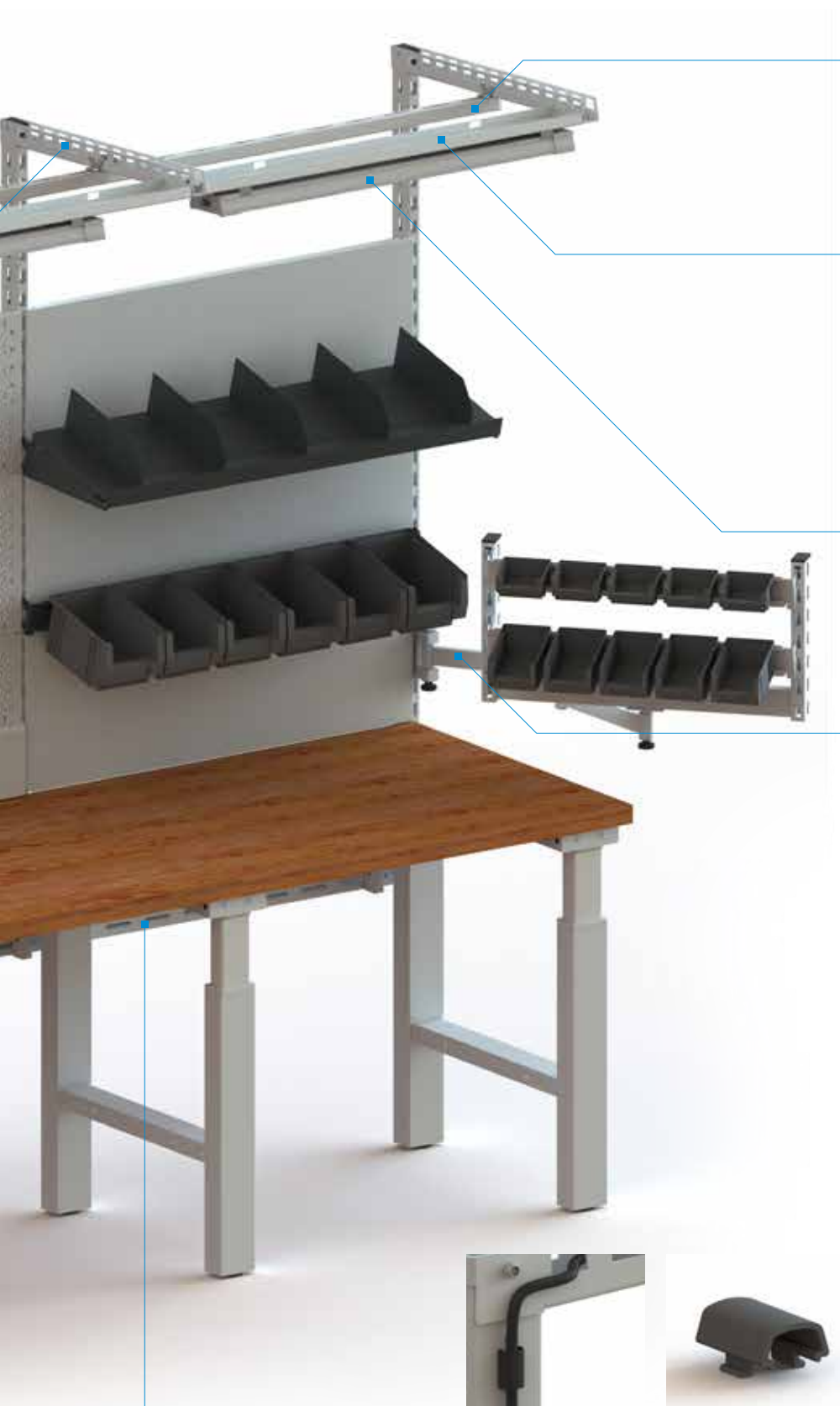

Equipment rail

- For use with carriages
- Fast and easy assembly
- Linking possible via multiple workstations

see page 19



Integrated lighting carrier

- For accommodating lighting and cabling.
- Interlocking design for almost invisible cabling

see page 19

Lighting

- Wide selection of different LED lights

see page 22

Swivel arm

- For mounting on support pillar
- One or two arms
- For holding peripheral devices and accessories

see page 23



ESD

- ESD protected version available as an option

see page 25

Guide rail

- For fastening and horizontal positioning of support pillars

see page 18

Cable routing clip

- Enables clean cable routing, easy installation and removal
- Suitable for support pillars and perforated rear panels

see page 21



SUPPORTS/CANTILEVERS/REAR PANELS

Configurations		Rear panels optional (as room divider or for rear use)					
A	Support pillar height	700	1050	1400	1900	1800	
B	Usable height	350	700	1050	1050	1400	
C	Number of rear panels at front	Height 350*	1	2	3	3	3
		Height 500	–	–	–	1	–
D	Number of rear panels at rear	Height 350**	2	3	4	4	5
		Height 500	–	–	–	–	–

* Alternative variant: Power conduit cover plate 150 mm (cf. page 20) with a rear panel 200 mm

** Alternative variant: Rear panel with integrated cable duct (cf. page 20)

!

Module width of superstructures

The module width refers to the axis dimension of the superstructures (measured from the centres of the support pillars). The number and dimensions of the modules used may vary depending on the frame and top width. We will be happy to advise you.

M Module width

G Frame width

P Top width

Support pillar for mounting on workbench substructure

Scope of delivery: 1 unit



	Height mm	Usable height mm	Art. no.
	700	350	89.225.XXX
	1050	700	89.226.XXX
Workbench leg assembly	1400	1050	89.227.XXX
move workstation leg, H design	1800	1400	89.228.XXX
move workstation frame, H design	1900	1050	89.229.XXX
	1000	350	65.128.XXX
move workstation frame, C design	1700	1050 / 1150	65.129.XXX

Guide rail

Only necessary for workbench leg assembly and move workstation leg assembly, H design. Scope of delivery: 1 pair.



Width mm	665	750	1000	1330	1500	2000	2500	3000
Art. no.	–	–	89.140.XXX	–	89.141.XXX	89.142.XXX	89.143.XXX	89.144.XXX

* When using drawer cabinet T: 27E, a TWIN-Link adapter is required. We will be happy to advise you.

Cantilever



	Art. no.
Simple.	89.232.XXX
Double-sided	89.233.XXX

Support pillars for mounting onto countertops

The support pillars are available in four different heights and must be screwed directly onto the top surface on site using the fastening material provided. Capacity 100 kg. Model: Steel profile, perforated on four sides in increments of 50 mm for attaching the superstructure components with minimum use of screws. Colour: as per colour chart. Only suitable for mounting on countertops made from beechwood and multiplex. Plate thickness min. 40 mm.



Pillar height mm	Left	Centre	Right
350	89.423.XXX	89.420.XXX	89.424.XXX
700	89.425.XXX	89.421.XXX	89.426.XXX
1050	89.952.XXX	89.954.XXX	89.953.XXX
1400	89.427.XXX	89.422.XXX	89.428.XXX

Support bracket

To provide additional stability for the support pillars on the countertop. Mandatory from pillar heights of 1400 mm. Model: Sheet steel. Colour: as per colour chart.



	Art. no.
Left	89.433.XXX
Right	89.434.XXX

Equipment rail



Width mm	665	750	1000	1330	1500	2000	2500
Art. no.	89.240.XXX	89.241.XXX	89.242.XXX	89.244.XXX	89.245.XXX	89.246.XXX	89.247.XXX

Lighting support



Module width mm	665	750	1000	1330	1500	2000
Art. no.	89.234.XXX	89.235.XXX	89.236.XXX	89.237.XXX	89.238.XXX	89.239.XXX

Rear panels



Plain

Perforated

Module width mm	665	750	1000	1330	1500	2000	2500
Height mm							
200	89.031.XXX	89.032.XXX	89.033.XXX	89.034.XXX	89.035.XXX	89.036.XXX	-
350	89.043.XXX	89.044.XXX	89.045.XXX	89.046.XXX	89.047.XXX	89.048.XXX	-
500	89.049.XXX	89.050.XXX	89.051.XXX	89.052.XXX	89.053.XXX	89.054.XXX	-
200	89.025.XXX	89.026.XXX	89.027.XXX	89.028.XXX	89.029.XXX	89.030.XXX	-
350	89.037.XXX	89.038.XXX	89.039.XXX	89.040.XXX	89.041.XXX	89.042.XXX	-

Cable trough

Height 350 mm



Module width mm	665	750	1000	1330	1500	2000	2500
Art. no.	89.055.XXX	89.056.XXX	89.057.XXX	89.058.XXX	89.059.XXX	89.60.XXX	-



For colour information, see p. 31. When ordering, please use the desired three-digit colour code (instead of XXX).

POWER SUPPLY

Rear power panels and housings



Rear panels
Height 150 mm for hanging in the support pillars



Housing
Height 150 mm for direct mounting on the countertop

! Please note:
All power elements must be wired on site.

Rear power panel for power modules	Module width mm	665	750	1000	1330	1500	2000
	Layout	---	---	---	---	---	---
	Number of power modules	2	3	4	5	6	8
	Art. no	89.014.XXX	89.015.XXX	89.016.XXX	89.017.XXX	89.018.XXX	89.019.XXX

Rear power panel for power modules and elements	Module width mm	665	750	1000	1330	1500	2000
	Layout					---	---
	Number of power modules					4	6
	Number of power elements					3	3
	Art. no	-	-	-	-	89.020.XXX	89.021.XXX

Housing	Module width mm	665	750	1000	1330	1500	2000
	Art. no	-	-	89.002.XXX	-	89.004.XXX	89.005.XXX

Power elements



Emergency stop switch* (Switching via the contactor)

89.100.000



400 V 16 A socket **

89.090.000



Compressed air connection* (In: G3/8" – Out: G 1/2")

89.105.000



Blind adapter plate

89.088.000



CEE 240 V socket*

CH	89.101.000
Schuko	89.102.000
FR	89.103.000
GB	89.104.000

* Incl. adapter plate
** Direct mounting, without adapter plate

When using the emergency stop switch, 400 V socket or CEE 240 V, a protective cover on the rear must be fitted on site.

Power modules

					
Power module 1 1× switch 1× socket outlet 230 V	Power module 1 type CH 1× overcurrent protection (thermal fuse 10A) 1× switch	Power module 2 2× socket 230 V	Power module 3 1× single-pin circuit breaker (CH: 10 A, Schuko: 16 A)	Power module 4 1× FI safety switch 16 A/30 mA	Power module 6 Emergency stop button
				89.541.000	89.540.000
CH (type J)	89.598.000	89.530.000	89.579.000		
Schuko (type F)	89.535.000	89.531.000	89.542.000		
FR (type E)	89.536.000	89.532.000			
GB (type G)	89.537.000	89.533.000			

					
Blind cover for subsequent addition of power modules	Power module 7 2× 2 RJ45 network sockets, without network cable, plug + play, cat 6	Power module 8 2× DN7 compressed air connections, input: DN5 plug-in nipple, output: DN5 quick-release coupling	Power module 9 1× socket outlet 230 V 2× power USB	Power module 10 1× socket outlet 230 V 2× RJ45, without network cable, plug + play, cat 6	Power module 11 1× overcurrent protection (thermal fuse 10A) 1× socket outlet 230 V
89.543.000	89.538.000	89.539.000			
CH (type J)			89.389.000	89.388.000	89.595.000
Schuko (type F)			89.385.000	89.381.000	–
FR (type E)			89.386.000	89.382.000	–
GB (type G)			89.387.000	89.383.000	–

Power and connection cables



System socket power cable

Simple and quick electrical installation via 3-pin connector system. Length: 3 m.

CH	89.544.000
Schuko	89.545.000
FR	89.545.000
GB	89.546.000



Intermediate coupling

For interlinking power modules 1 – 4 and 6. Power modules which are not mounted next to one another are connected via a connection cable. Colour: black.

I type	89.552.000
T type	89.551.000



Connection cable

3-pin connector system with socket and plug.

0.5 m	89.547.000
1 m	89.548.000
2 m	89.549.000
3 m	89.550.000



Cable routing clip

Set 8 ×	89.024.000
----------------	------------

LIGHTING

LED Comfort +



LED workstation lamp

For mounting on the equipment rail. With on/off switch and Wieland power connector GST-18. Continuously dimmable. Glare suppression: structured cover. Colour temperature: neutral white 5000 K. Colour rendering: Ra > 80. Model: Aluminium housing, anodised colourless. Including fastening material. Without power and connection cables. A Waldmann development.

Also available as side lighting. Length: 450 mm. Assembly on the right: Art. no. 89.268.000, left assembly: Art. no. 89.269.000

Length mm	Power W	Luminous flux lm	max. illuminance lx*	System connection GST-18	Installation	Art. no.
450	15	1100	499	Input	-	89.265.000
900	35	3000	1279	Input/Output	-	89.266.000
1500	63	5000	1770	Input/Output	-	89.267.000

* Measurement field 100×100 cm / Measuring distance: 100 cm



Articulated LED overhead lamp

For mounting on the support pillar or any position on the tabletop. With on/off switch. Continuously dimmable. Glare suppression: structured screen. Colour temperature: neutral white 5000 K. Colour rendering: Ra > 80. Arm length: 823 mm. Model: Plastic housing and articulated arms made of aluminium, anodised colourless. Including table clamp. Separate mounting bracket for mounting support pillar: Colour: grey, item no. 89.183.000. Including 3 m network cable; mains plug CEE 7/16 (Europlug), BS 1363 and NEMA 1-15P. A Waldmann development.

Length mm	Power W	Luminous flux lm	max. illuminance lx*	Ballast	Assembly	Art. no.
360	14	1330	2604	100 – 240 V, 50/60 Hz	-	89.270.000

* Measurement field 100×100 cm / Measuring distance: 50 cm



Articulated LED magnifier lamp

For mounting on the support pillar or any position on the tabletop. With on/off switch. Continuously dimmable. Colour temperature: neutral white 5000 K. Colour rendering: Ra > 80. Arm length: 823 mm. Model: Plastic housing and articulated arms made of aluminium, anodised colourless. Including table clamp. Separate mounting bracket for mounting support pillar, colour: grey, art. no. 89.183.000. Including 3 m network cable; mains plug CEE 7/16 (Europlug), BS 1363 and NEMA 1-15P. A Waldmann development.

Length mm	Power W	Dioptres	Luminous flux lm	max. illuminance lx*	Ballast	Art. no.
∅ 160	15	3.5	-	7070	100 – 240 V, 50/60 Hz	89.271.000

* Measurement field 30×30 cm / Measuring distance: 15 cm

LED Comfort



LED workstation lamp

For mounting on the equipment rail. With on/off switch and Wieland power connector GST-18. Colour temperature: Neutral white 5000 K. Colour rendering: Ra > 80. Model: PVC plastic housing, white. Including fastening material. Without power and connection cables.

Also available as side lighting. Length: 450 mm. Art. no. 89.275.000

Length mm	Power W	Luminous flux lm	max. illuminance lx*	System connection GST-18	Installation	Art. no.
450	10	1000	367	Input	-	89.272.000
900	30	3000	1073	Input/Output	-	89.273.000
1500	50	5000	1904	Input/Output	-	89.274.000

* Measurement field 100×100 cm / Measuring distance: 100 cm

SWIVEL ARMS

Swivel arm fixing device

For mounting the swivel arm elements directly on the move workstation frame, C design, or on the support pillar. Model: steel. Colour: RAL 7035 pale grey. Table frame holder galvanised.

Fixing to	Width mm	Height mm	Depth mm	Load kg	Art. no.
Table frame	30	280	30	25	65.244.000
Support pillar	30	105	123	25	65.346.000



Swivel arm

Version as double swivel arm with one axis and one swivel arm element. The swivel arm elements are fitted with internal slide bearings.

Model	Length mm	Load kg	Art. no.
Double swivel arm	2×300	25	65.347.000



Module frame for swivel arm

Welded tubular steel frame with 4-sided perforation, 50 mm apart, and steel axis for attachment to the swivel arm element. Load capacity: 25 kg. Model: sheet steel. Colour: RAL 7035 pale grey.

Version with	Width mm	Height mm	Depth mm	Art. no.
1 rear panel	665	350	65	65.350.000
2 adjustable shelves*	665	350	265	65.351.000
2 swivel shelves	665	350	424	65.353.000
3 container strips	665	350	90	65.352.000



* Depth of adjustable shelf 200 mm

Swivel shelf for swivel arm

With steel axis for attachment to the swivel arm element and stop bar on both sides. Tilt angle can be continuously adjusted by up to 30°. Model: sheet steel. Colour: RAL 7035 pale grey.

Width mm	Height mm	Depth mm	Load kg	Art. no.
300	72	426	25	65.354.000



Figures in mm

TFT monitor holder

For attaching flat screens with a VESA base plate. Hole pattern 75×75 mm or 100×100 mm. Continuously adjustable inclination.

Specification	Width mm	Height mm	Depth mm	Art. no.
For swivel arm	120	155	60	65.356.000



Keyboard support for TFT monitor holder

For mounting on the monitor holder. Model: sheet steel. Colour: RAL 7035 pale grey.

Specification	Width mm	Height mm	Depth mm	Art. no.
Keyboard support	500	200	115	65.357.000



ACCESSORIES



Container strips

For attaching storage containers, sizes 2, 3 and 4. Can be attached to the support pillars without screws. Max. load capacity 15 kg. Model: sheet steel. Colour: as per colour chart.

Module width mm	665			750			1000			1330			1500			2000		
Height 85 mm	65.234.XXX			89.460.XXX			65.085.XXX			65.235.XXX			89.461.XXX			89.462.XXX		
Container size	2	3	4	2	3	4	2	3	4	2	3	4	2	3	4	2	3	4
Number of containers	6-12	6	4	7-14	7	5	9-18	9	6	12-24	12	18	14-28	14	10	19-38	19	13



Adjustable shelves, plain or slotted

The adjustable shelves are equipped with a stop bar on one long side and can be mounted either with the stop bar at the front or rear. They are attached to the support pillars with two brackets without screws (horizontally or inclined 15°). Load capacity 50 kg. Base height 25 mm plus 17 mm stop bar. Slotted adjustable shelves with slotted partition 15 mm apart for subdividing with dividers. Brackets included. Model: sheet steel. Colour: as per colour chart.

	Module width mm	665	750	1000	1330	1500	2000
Model	Depth mm						
Plain	300	65.258.XXX	89.901.XXX	65.132.XXX	65.264.XXX	89.843.XXX	89.844.XXX
	350	89.845.XXX	89.902.XXX	89.903.XXX	89.846.XXX	89.847.XXX	89.848.XXX
Slotted	300	89.822.XXX	89.823.XXX	89.824.XXX	89.825.XXX	89.826.XXX	89.827.XXX
	350	89.828.XXX	89.829.XXX	89.830.XXX	89.831.XXX	89.832.XXX	89.833.XXX



Carriage for component rails

Carriage for accommodating cable winches and tools. With four high-quality ball bearings including two end stops for restricting the travel path. Load capacity 5 kg. Screw fixtures included. Specification: Steel structure, bright galvanised finish.

	Art. no.
Carriage including two end stops for restricting the travel path	89.452.000

ESD WORKSTATIONS

Electrostatic discharge or ESD can impair or destroy the function of electric, electronic or electromechanical components. LISTA supplies workshop equipment in an ESD-safe version to reliably protect electrical and other sensitive parts and components in production, storage and assembly from damage. Our ESD solutions comprise of a broad spectrum of ESD-safe equipment from workstations to lamps and accessories all with protection. The LISTA system enables the configuration of every workstation according to individual requirements and thereby ensures complete ESD protection.

LISTA ESD workstations

- Optimum protection for your electronic components during processing and storage
- Effective cost reduction due to fewer missing parts
- Comprehensive ESD product range for minimum to full protection
- Competent planning of ESD workstations and plant equipment

ESD protection in practice



Workstations

In an ESD protective zone, every workstation should be equipped with ESD protection. Electrostatic charges are dissipated in a controlled manner via the working surface and grounding cable so that the workstation stays charge-neutral.

Personnel grounding

People are a primary source of electrostatic charges. As such, it is recommended that employees working in electronics manufacturing wear a wrist strap with a grounding cable and antistatic shoes. Desk chairs and standing aids should also have ESD protection.



Storage

Electronic components are best stored in closed ESD drawers, hinged-door cabinets as well as ESD shelving (Faraday cage) with appropriate ESD containers.



Marking

ESD-protected areas must be marked. In addition, it is advisable to indicate components that are at risk with appropriate signs or labels.

MATERIAL FLOW 4.0

In addition to individual workstation design, the transport of goods and material within the company is a decisive criterion for efficiency and productivity. The automation of intralogistics makes a valuable contribution here to further process optimisation. For this reason, LISTA offers a range of driverless transport systems (DTS) that are optimally matched to the workstation system.

Whether from warehouse to production, from assembly to shipping, whether individual part, box or pallet: our driverless transport systems transport your loads safely and cost-effectively on freely programmable routes through your plant. Automated transport is controlled by a central WMS and ensures optimal distribution and networking. In other words, you have the right material in the right place at the right time and benefit from fewer errors and staffing requirements with higher speed and efficiency.

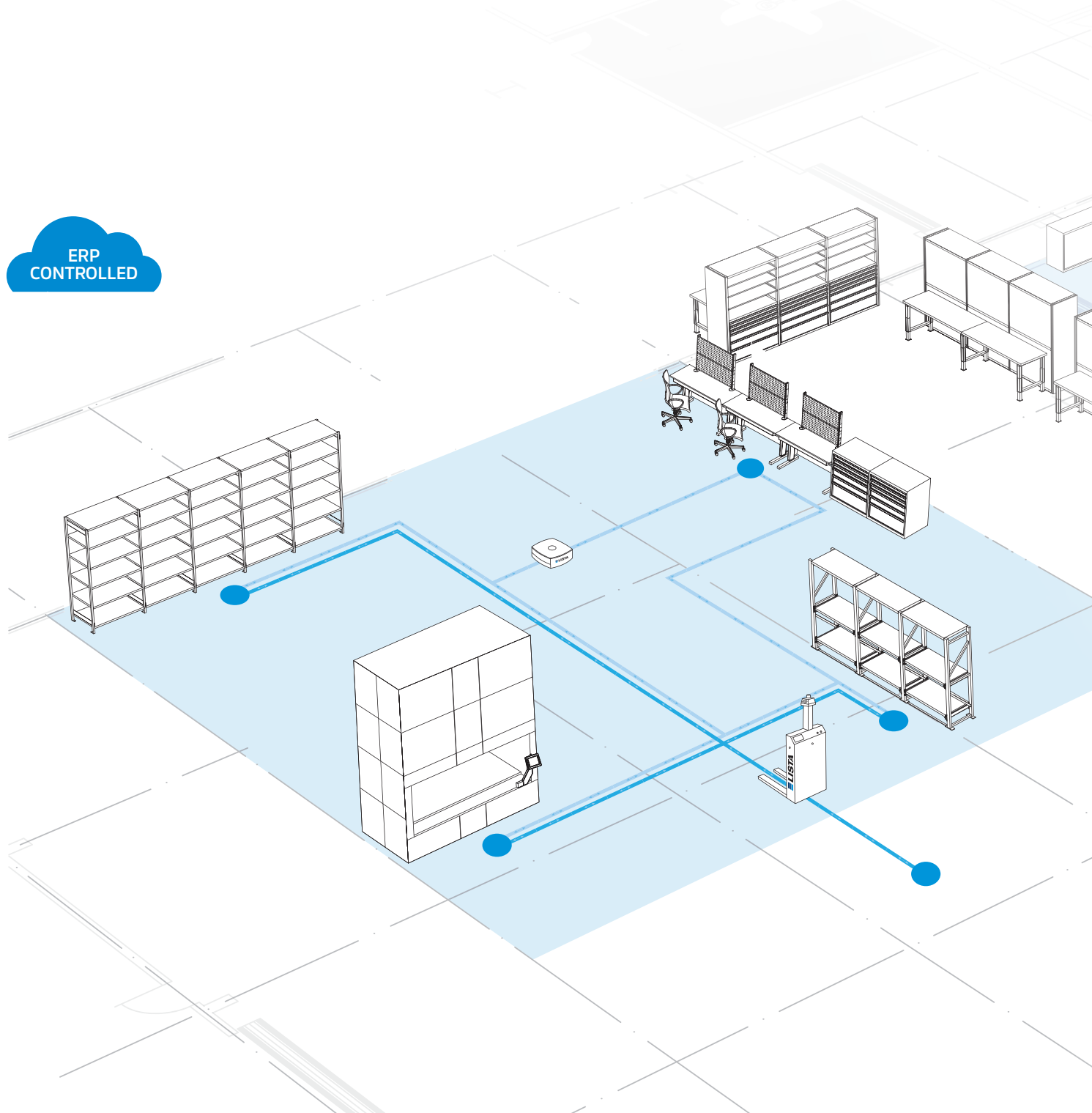

Your advantages with LISTA driverless transport systems at a glance:

- Automated product movement
- Fast storage and retrieval
- Decreasing error rate
- Reduced product damage
- Reduced labour requirements
- Greater flexibility in the warehouse
- Improved safety at the workstation
- Unique price-performance ratio



Driverless transport system
FLOW



Driverless transport system
SLIM

ERGONOMICS AT LISTA

The LISTA workstation system is consistently geared towards ergonomic work and thereby demonstrably contributes to improving workflows, a lower error rate and increased productivity. Thanks to its numerous configuration options, it allows workstations to be flexibly adapted to individual requirements, taking into account the criteria of a clear and efficient workstation design in accordance with 5S. As a result, the LISTA workstation system is also optimally suited for lean environments.

- The main advantages of ergonomic workstation design include:
- Increasing quality through simplified workflows and decreasing error rate
 - Reduction of lead times
 - Up to 20% increased efficiency
 - Long-term reduction in costs due to healthier work and reduced downtimes

Important aspects of ergonomic workstation design

Mobility

If possible, design assembly workstations so that you can both sit and stand at them. If it is not possible to switch between sitting and standing, a sitting posture is recommended.

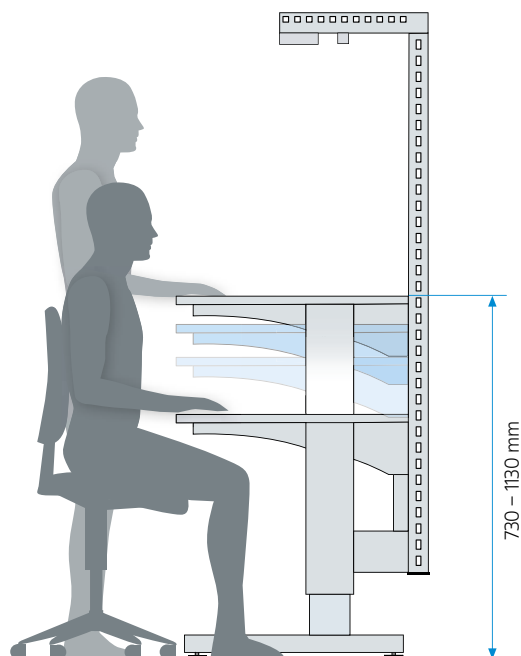

Working height

The optimal working height when sitting or standing can be determined and individually adjusted using anthropometric values

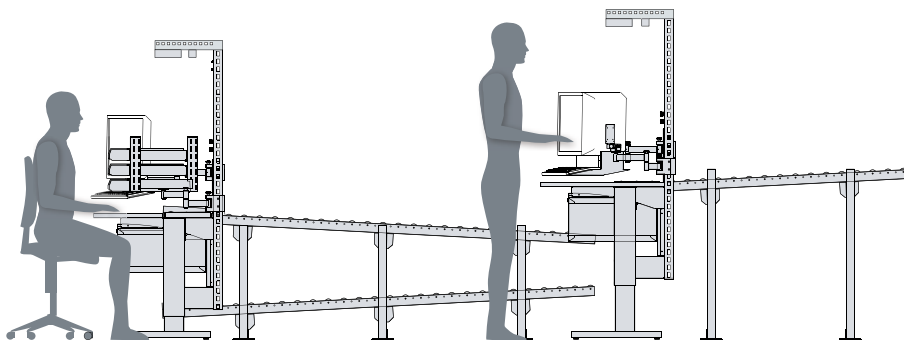

Sitting or standing position? This is considered optimal:

- Two to four changes in posture per hour
- Standing phases not longer than 20 minutes
- Avoid static sitting and standing

at most:

- Two hours continuously in a sitting position
- One hour continuously in a standing position

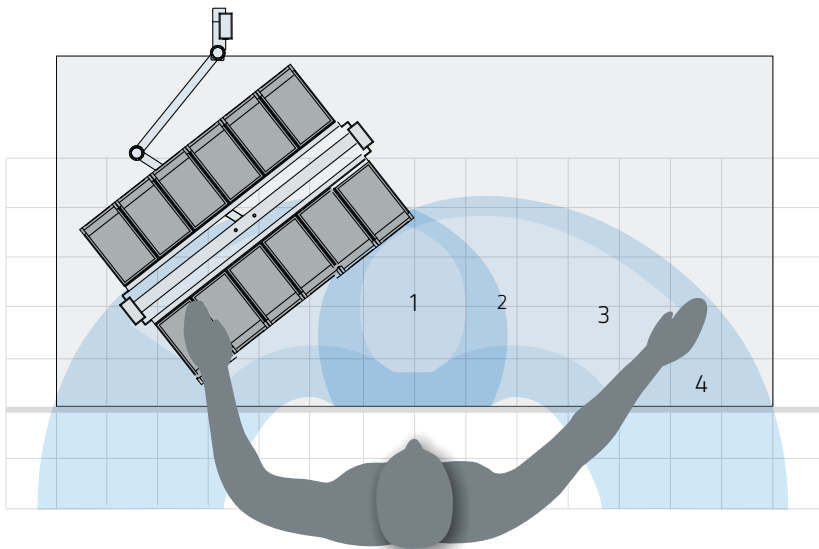

Space within reach

Based on average human body dimensions, there are four access zones on the table top of the workstation with different priorities:

1. Work centre: Both hands work in the direct field of vision
2. Extended work centre: Both hands reach all areas of this zone
3. One-hand zone: Parts and tools are within easy reach of one hand
4. Extended one-hand zone: Outermost usable zone

Optimum arrangement of grab containers in zone 2 and 3 right beside the workpiece

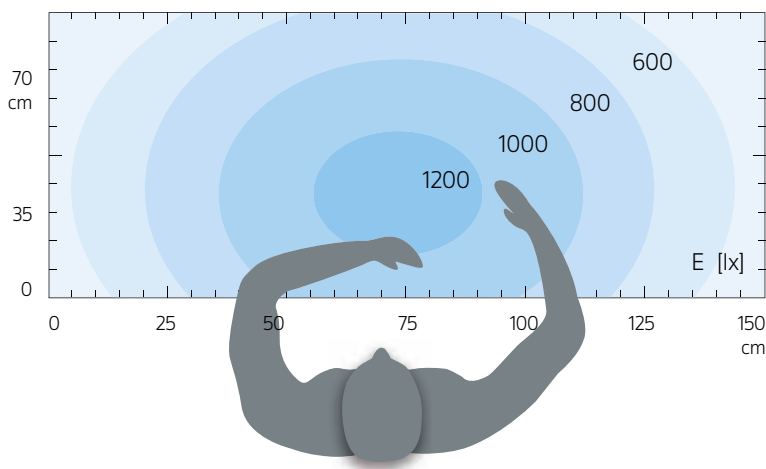

Lighting

Good lighting helps to reduce error rates caused by overstrained eyes. This increases both the performance of the workforce and the quality of production. The required illumination level is determined by the respective assembly activities.

COMPLEMENTARY SOLUTIONS AND PRODUCTS

Would you like to connect several workstations or place a workbench within a small space? To match the LISTA workstation system, we have a range of complementary solutions and products to complete

your application. Extension units, assembly trolleys or special workbench solutions create optimal conditions for smooth workflows and a productive working environment that is state of the art.



Team workstations

Beyond the individual workstations, the LISTA workstation system enables flexible linking and networking of several elements into the individual team workstation. Thanks to the modular structure, a wide variety of work and assembly lines can be created, which can later be modified and extended without great effort. As an integrated solution, LISTA team workstations make a key contribution to workflow management and offer the same ergonomic and efficiency advantages as our individual workstations.

Assembly trolley

A valuable addition to the LISTA workstation system is the flexible and individually configurable LISTA assembly trolley. Easily and effectively optimise the material flow between individual workstations, warehouse and shipping: Our assembly trolleys enable fast transportation and interim storage of components or assemblies without requiring a lot of space and by combining various elements, they can be adapted specifically to individual requirements.



Compact workbenches

LISTA compact workbenches offer a clear and space-saving workstation in workshops and production. Their robust design and high material quality make them exceptionally resilient and effortlessly withstand even the toughest conditions of use. Variable substructures enable storage space to be flexibly adapted to the requirements of the workstation.



Hexagonal workbenches

The space-saving hexagonal workbenches with vices are ideal as group workstations, especially for training centres. Every workstation has a large working surface and a drawer cabinet as a substructure. The power outlets are integrated into the centre pillar.



Further details on the products shown can be found in the main catalogue. We will be happy to advise you.

FREE CHOICE OF COLOURS

The LISTA workstation system is available in twelve standard colours, twelve further predefined colour variants and, on request, in any colour and colour combination. This allows you to design each workstation completely flexibly and individually. Different

colours for different work areas, coloured accents to increase clarity or complete company facilities in the corporate design: It's all possible. To order, simply use the three-digit colour code. Or contact us.



.010 Light Blue RAL 5012	.020 Light Grey RAL 7035	.030 Reseda Green RAL 6011	.040 Capri Blue RAL 5019	.050 Metallic Grey NCS S 6502-B	.060 Black NCS S 9000-N
.070 Ruby Red RAL 3003	.080 Dove Grey NCS S 4502-B	.090 Gentian Blue RAL 5010	.100 Signal Blue RAL 5005	.110 Pure White RAL 9010	.180 Grey White RAL 9002

An additional 12 predefined colours are available at extra cost

.120 Grey Aluminium RAL 9007	.130 White Aluminium RAL 9006	.140 Light Grey NCS S 2000-N	.170 Ultramarine Blue RAL 5002	.190 Sky Blue RAL 5015	.200 Anthracite Grey RAL 7016
.210 Brilliant Blue RAL 5007	.220 Turquoise Blue RAL 5018	.230 Pebble Grey RAL 7032	.240 Flame Red RAL 3000	.260 Slate Grey RAL 7015	.280 Orange RAL 2004

REFERENCES





ORDERING AND CONTACT

Do you need further information, personal advice or would you like to order a product? In addition to our production sites in Switzerland and Germany, the international LISTA sales companies will be happy to advise and assist you. We look forward to hearing from you.



Lista AG Switzerland

Fabrikstrasse 1
CH-8586 Erlen

Telephone +41 71 649 21 11
Fax +41 71 649 22 03
info@lista.com

LISTA Italia s.r.l. Italy

Telephone +39 02 935 70 196/362
Fax +39 02 935 70 417
info.it@lista.com

LISTA GmbH Germany

Brückenstrasse 1
D-51702 Bergneustadt

Telephone +49 2261 40 30
Fax +49 2261 40 32 22
info.de@lista.com

LISTA France France

Telephone + 33 4 50 31 71 71
Fax + 33 4 50 31 71 79
info.fr@lista.com

LISTA Austria GmbH Austria

Telephone +43 1 291 20
Fax +43 1 291 204
info.at@lista.com

LISTA Sistemas de Almacenaje, S. Spain

Telephone +34 938 575 927
info.es@lista.com

LISTA (UK) Ltd. United Kingdom

Telephone +44 1 908 222 333
Fax +44 1 908 222 433
info.uk@lista.com

LISTA customer care

Australia ▪ Austria ▪ Albania ▪ Azerbaijan ▪ Bahrain ▪ Belarus ▪ Belgium ▪ Bosnia-Herzegovina ▪ Bulgaria ▪ China ▪ Croatia ▪ Czech Republic ▪ Denmark ▪ Estonia ▪ Egypt ▪ Finland ▪ France ▪ Germany ▪ Greece ▪ Hong Kong ▪ Hungary ▪ Iran ▪ Israel ▪ Italy ▪ India ▪ Indonesia ▪ Japan ▪ Jordan ▪ Kazakhstan ▪ Kuwait ▪ Latvia ▪ Liechtenstein ▪ Lithuania ▪ Malaysia ▪ Montenegro ▪ Netherlands ▪ New Zealand ▪ North Macedonia ▪ Norway ▪ Oman ▪ Pakistan ▪ Philippines ▪ Poland ▪ Portugal ▪ Romania ▪ Russia ▪ Saudi Arabia ▪ Serbia ▪ Singapore ▪ Slovakia ▪ Slovenia ▪ Spain ▪ South Korea ▪ Sweden ▪ Switzerland ▪ Taiwan ▪ Thailand ▪ Turkey ▪ Turkmenistan ▪ United Arab Emirates ▪ United Kingdom ▪ Uzbekistan ▪ Qatar ▪ Yemen ▪

LISTA AS A PARTNER WELCOME TO THE NO.1

LISTA offers organisation. With success, experience and a systemic approach. For more than 70 years, we have offered our customers concepts for more organised and efficient working. Because we offer more than just a high-quality product, competent advice and a wide

range of services: The LISTA system creates perfect interlocking solutions for smooth work processes. And this makes us a leading partner in the area of workspace and storage equipment worldwide.



You can find further LISTA products and system solutions in our compact catalogue.

+ Comprehensive range
from A for access control to W for workstation systems

+ One system, countless possibilities
through freely combinable modules

+ Tailor-made solutions
for customers with specific requirements

+ Maximum flexibility
with a choice of colours, configuration options and more

+ Wide range of services
such as training, assembly, marking etc.

+ Expert planning
Individual and precisely fitting

+ Worldwide distribution and service network
for customer service without borders

+ First-class references
from more than 100,000 prestigious companies worldwide



www.lista.com